

MDV DIVERTER VALVE PILOT OPERATED 3W/2P

MDV SERIES

- Operating Pressure, max. : 360 bar [5,200 psi]
- Pilot Pressure, min. : 30 bar [435 psi]
- Zinc Coated Body
- Sub plate for Easy/ Clean Mounting
- 1" Conversion Kit [16CK] Available
- Solenoid Valve Cover [24DP] Optional

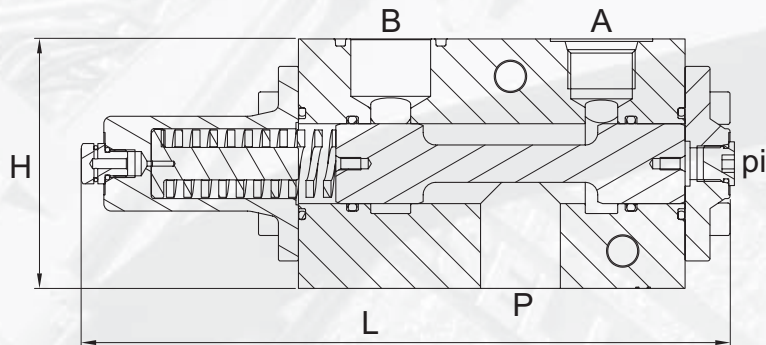

■ PORT

MODEL	P	A	B	pi
MDV2012A	1.25" Dia.	SAE ORB -12	CODE 62-20	SAE ORB -6
MDV2020B		SAE ORB -20		
MDV1212B		SAE ORB -12		

■ DIMENSIONS

MODEL	H [Height]		L [Length]		W [Weight]	
	mm	inch	mm	inch	kgs	lbs
MDV2012A	100	3-7/8	260	10-1/8	13	29
MDV2020B						
MDV1212B	90	3-1/2	190	7-1/2	6	13

■ INTERNAL LEAKAGE @ 100 bar [1,450 psi], 39cSt

MODEL	A [P to B]		A [P to B]	
	cc/min	cui/min	cc/min	cui/min
MDV2012A	6.3	0.39	8.3	0.51
MDV2020B	7.2	0.44	←	←
MDV1212B	6.1	0.38	←	←

MDV2012A

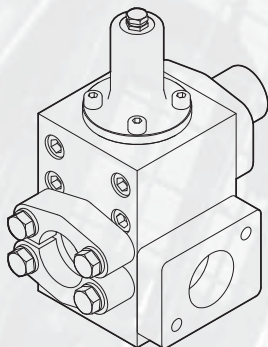

MDV2012A-16CK

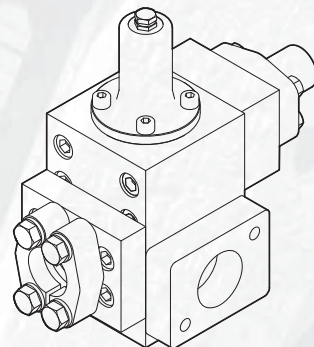

MDV2020B

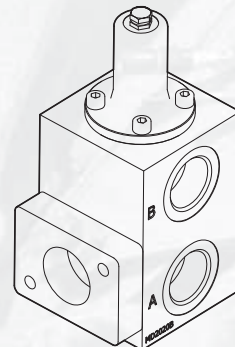

MDV2020B-24DP

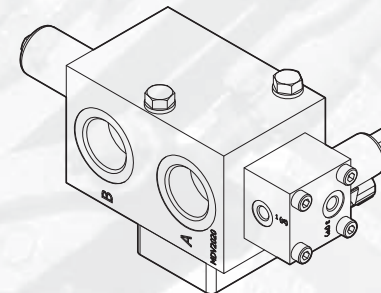

MDV1212B

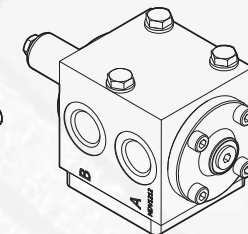

MDV DIVERTER VALVE PILOT OPERATED 3W/2P

HYD. SCHEMATIC

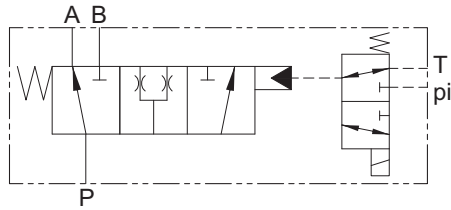

[w/ Solenoid End Cover]

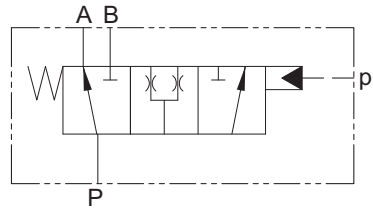

[w/ Standard End Cover]

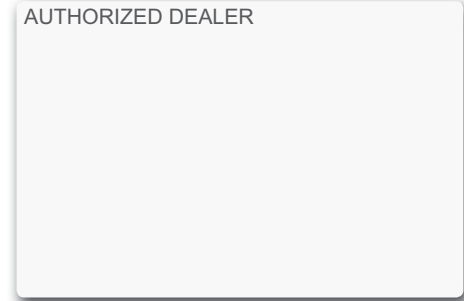

ΔP CURVE

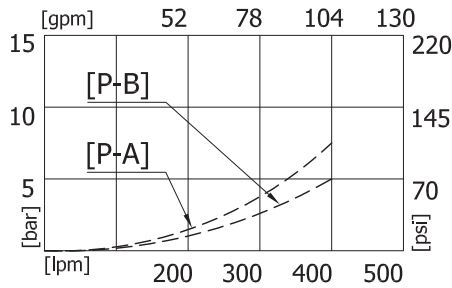

ΔP : 2012A

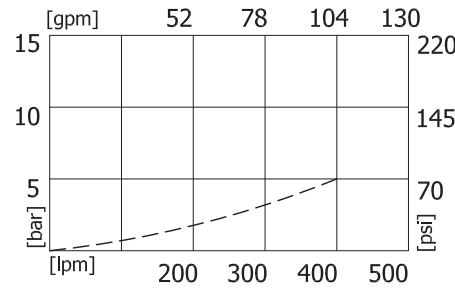

ΔP : 2020B

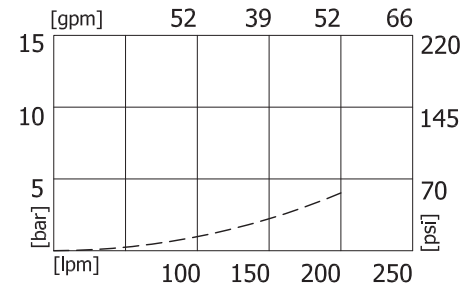

ΔP : 1212B

TYPICAL APPLICATION

